

# Operating instructions

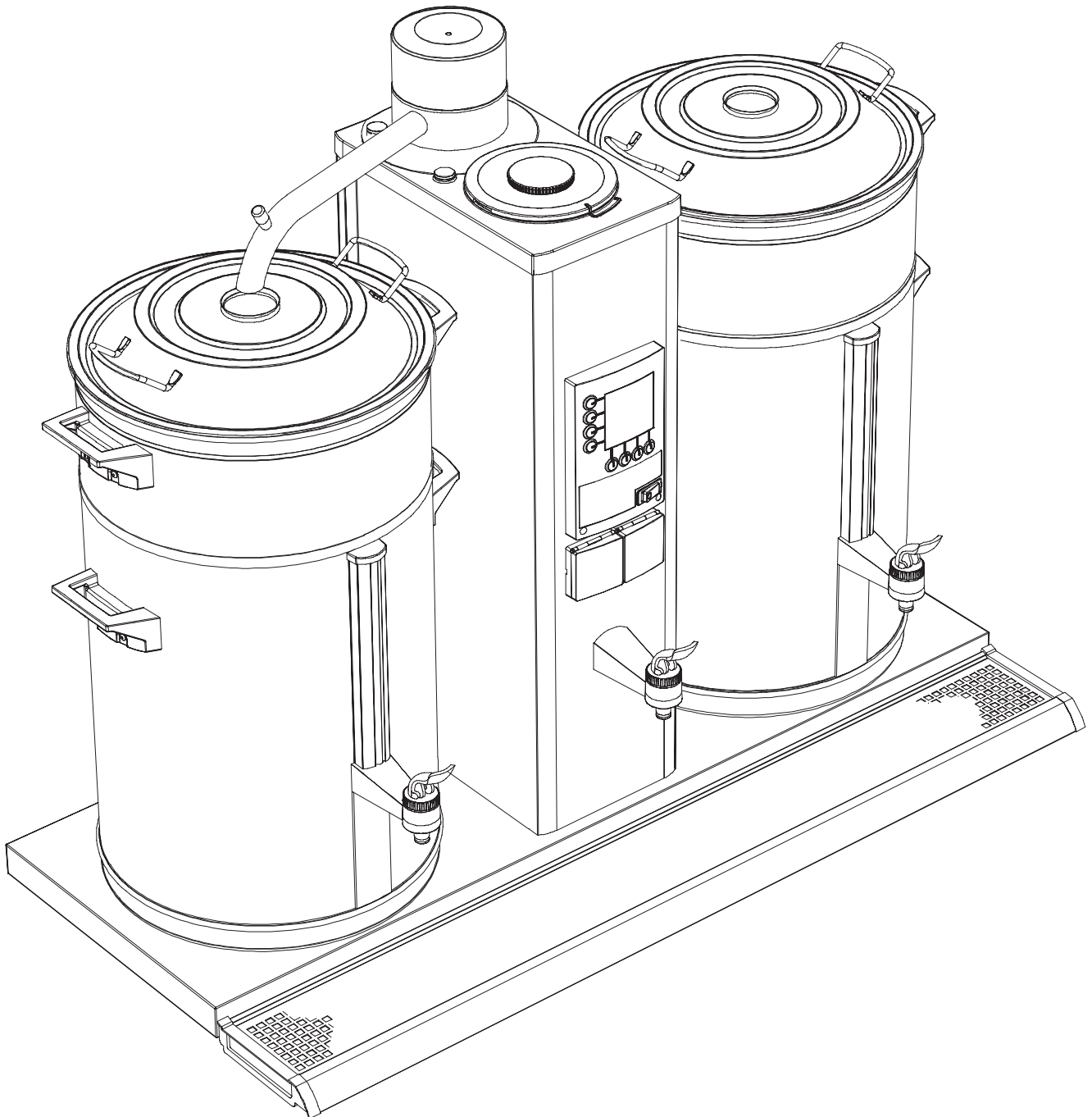

























## *Photos*

ROUND FILTER COFFEE BREWER  
WITH HOT WATER TAP



# ***B HW-series***

700.403.801

	English	Türkçe	Русский	Español	日本語	한글	中文
1.	 Use	Kullanım	Использование	Uso	使用	사 용	使用
	 Dripping	Damlama	Капание	Goteo	滴	추 출	滴水
2.	 Cleaning, frequently	Temizleme, sık sık	Очистка, регулярно	Limpieza frecuente	頻繁な洗浄	잦은 청소	清潔, 次數
	 Wait	Bekleme	Ожидание	Espera	お待ちください	대 기	等候
	 Acoustic signal	Sesli sinyal	Звуковой сигнал	Señal acústico	音信号	신호음	聽覺信號
3.	 Descaling	Kireçten Arındırma	Удаление накипи	Descalificar	スケール除去	스케일 제거	清除水垢
	 Read Operating Instructions	Kullanma Talimatini Oku	Чдаление накипи в системе горячей воды	Lea instrucciones de uso	取扱説明書参照	취급설명서 참조	閱讀操作說明
4.	 Descaling hot water system	Kireçten Arındırma	Удаление накипи системы горячего водоснабжения	Descalificar la sección de agua caliente	湯システムのスケール除去	더운물 디스케일링	熱水系統清除水垢
	 Very hot	Çok sıcak	Очень жарко	Muy caliente	非常に熱い	매우 뜨거움	很熱
5.	 Initial use	İlk kullanım	Первое использование	Uso inicial	使い初め	사용 초기	初次使用
6.	 Programming (operator)	Programlama (operatör)	Программирование (оператор)	Programación (operador)	(ユーザー)プログラミング	사용자 프로그래밍	程式(操作)
	 Selection keys	Seçme düğmeleri	Выбор клавиш	Tecla de selección	選択ボタン	선택 키	選擇按鍵
	 Confirm	Onayla	Подтвердить	Confirmar	確定	확 정	確定
	 Cancel	Iptal	Отменить	Cancelar	キャンセル	취 소	取消
	 Water hardness	Suyun sertliği	Жесткость воды	Dureza de agua	水硬度	수질 경도	水的硬度
	 Read Operating Instructions	Kullanma Talimatini Oku	Читайте инструкции	Lea instrucciones de uso	取扱説明書参照	취급설명서 참조	閱讀操作說明
7.	 Programming (principal)	Programlama (esas)	Программирование (оператор)	Programación (principal)	(主要な)プログラミング	프로그래밍(원리)	程式(主要的)
	 Selection keys	Seçme düğmeleri	Выбор клавиш	Tecla de selección	選択ボタン	선택 키	選擇按鍵
	 Confirm	Onayla	Подтвердить	Confirmar	確定	확 정	確定
	 Cancel	Iptal	Отменить	Cancelar	キャンセル	취 소	取消
	 Off	Kapali	Выключение	Apagado	オフ	오-프	關閉
	 Min.	En Az	Минимум	Min.	最小	최 소	最小
	 Standard	Standart	Стандарт	Estándar	標準	표 준	標準
	 Max.	En Fazla	Максимум	Max.	最大	최 대	最大
	 Water hardness	Suyun sertliği	Жесткость воды	Dureza de agua	水硬度	수질 경도	水的硬度
	 Read Operating Instructions	Kullanma Talimatini Oku	Читайте инструкции	Lea instrucciones de uso	取扱説明書参照	취급설명서 참조	閱讀操作說明
	Hold 10 sec.	10 san. Tut	Держите 10 секунд	Aguante 10 Segundos	10秒待機	10초간 대기	按著10秒
	Select desired time setting (1-14)	Istenilen zaman ayarini sec (1-14)	Выберите нужное время заваривания 1-14	Selecciona tiempo deseado (1-14)	時間設定(1-14)の選択	시간 설정(1-14)의 선택	選擇所需時間設定(1-14)
8.	Error codes	Arıza Kod	Коды ошибок	Códigos de mal función	エラーコード	에러 코드	錯誤的編號

## 1. USE (B HW)

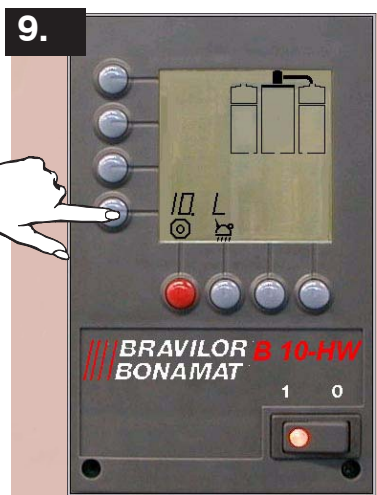
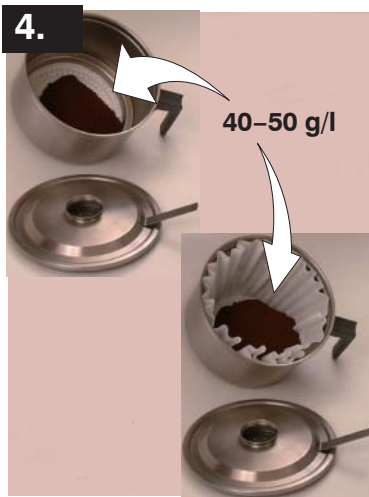
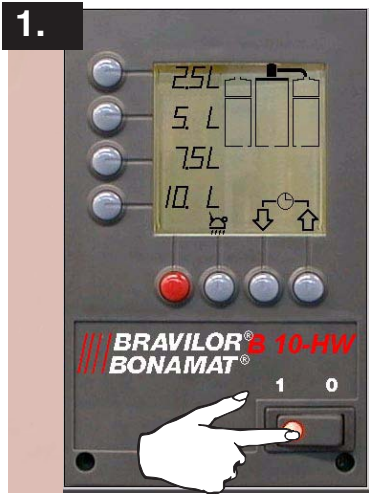

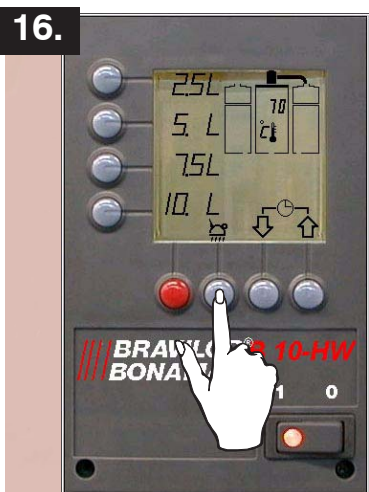

## 2. CLEANING, FREQUENTLY (B HW)

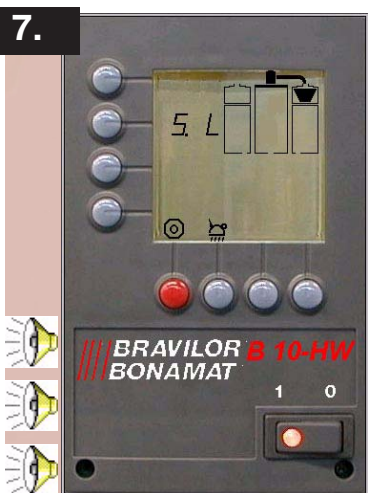
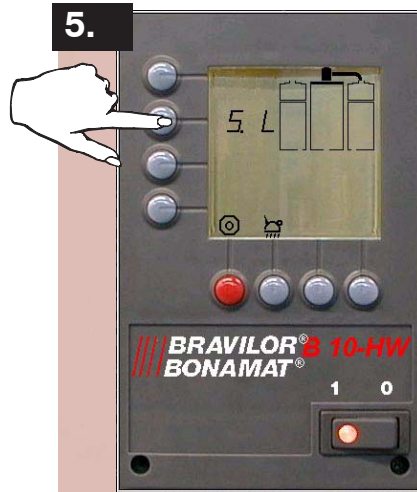
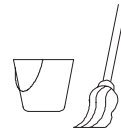

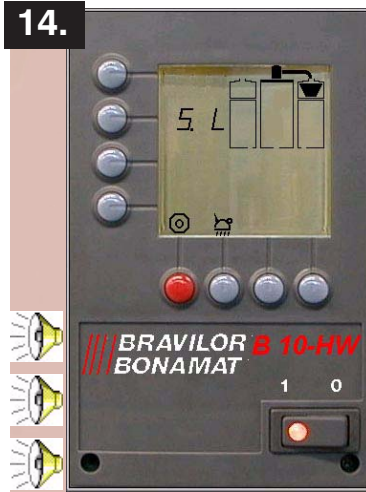







## 3. DESCALING COFFEE SYSTEM (B HW)

± 30 MIN.

(OPERATOR)

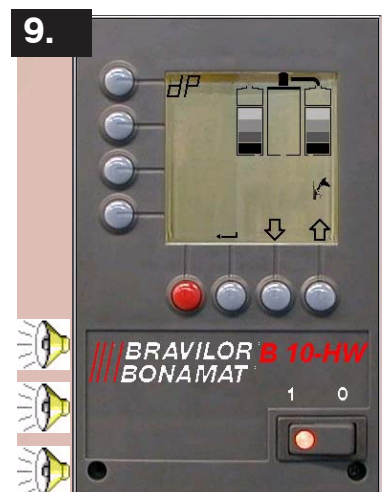
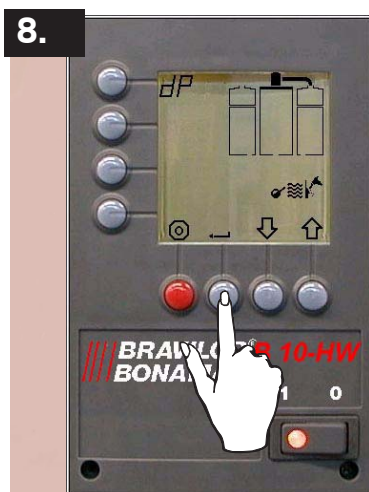
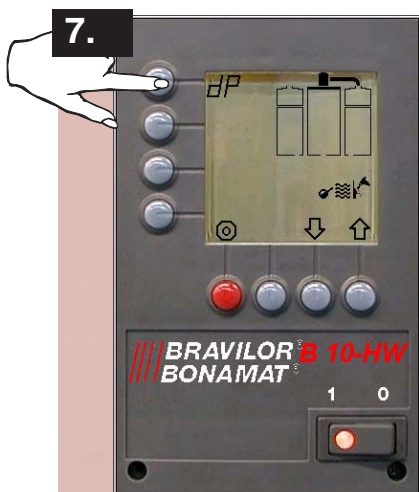
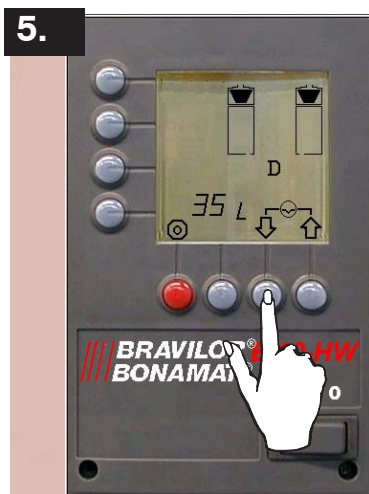
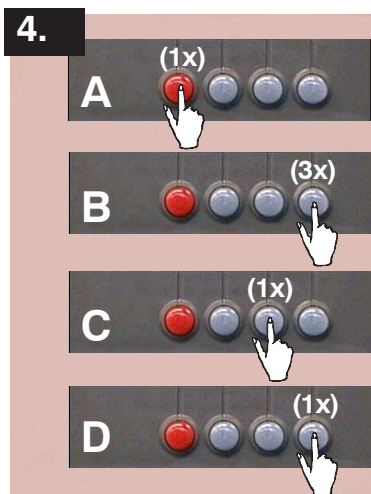

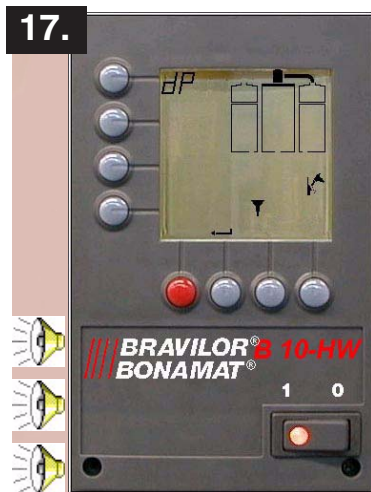
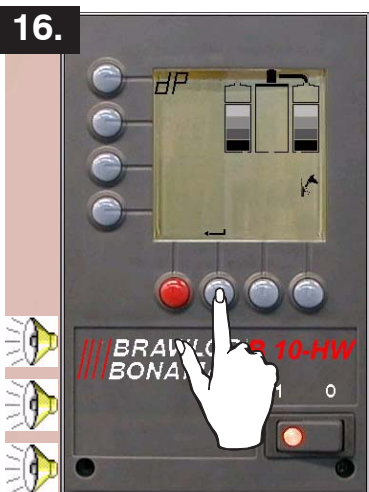
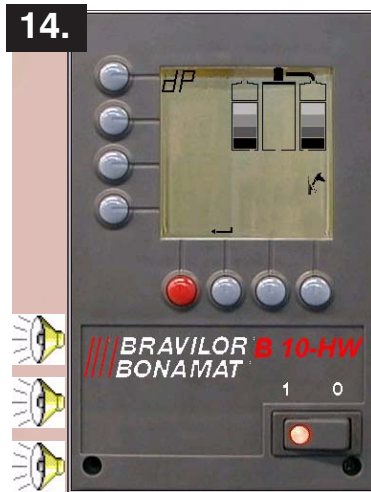
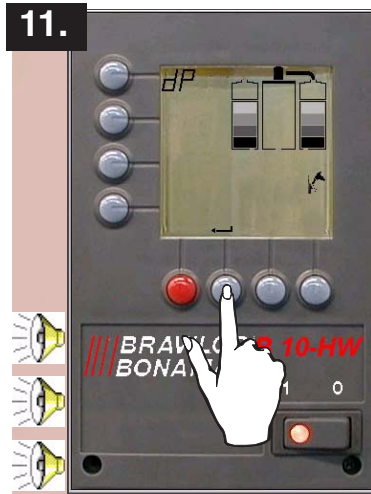

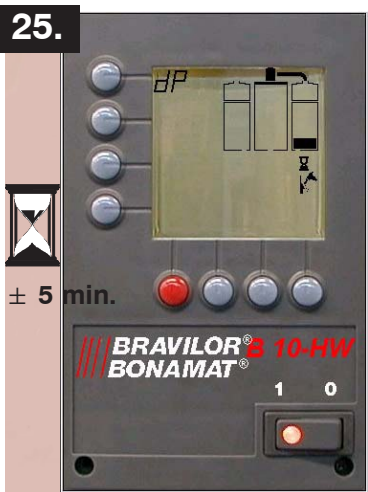
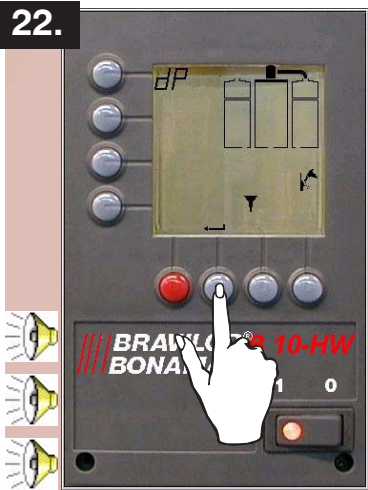

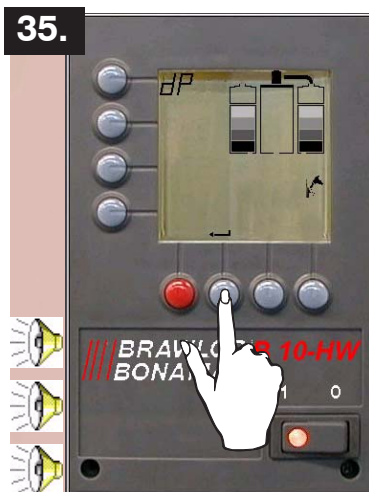
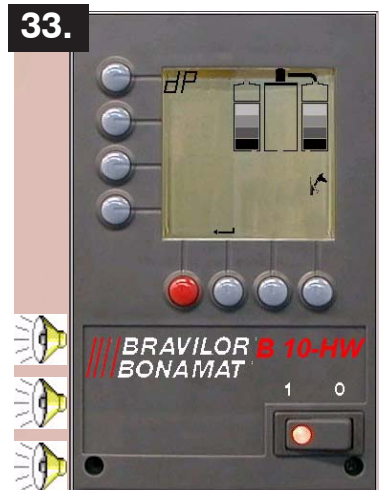
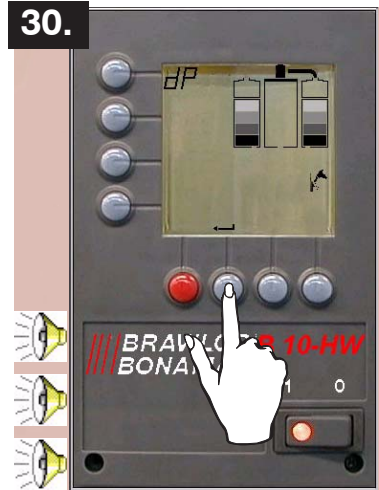
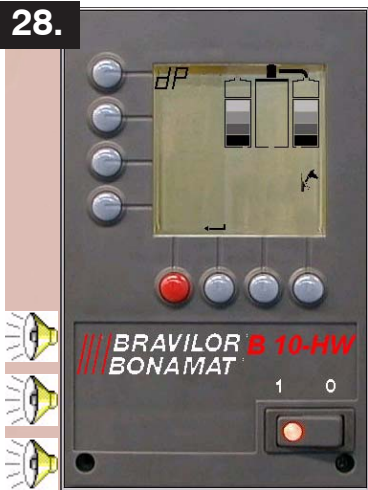

37.



38.

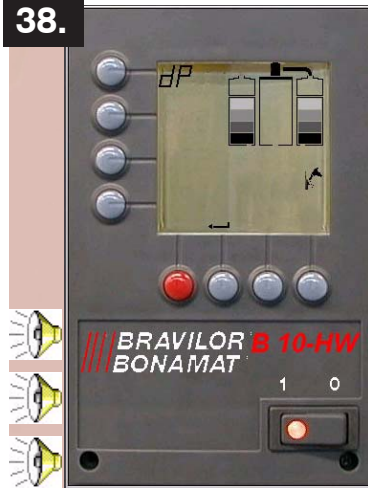

39.



40.

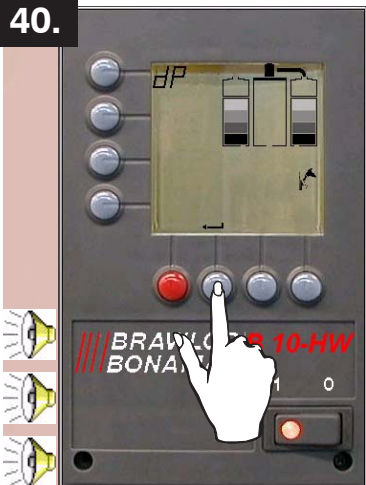

41.



42.



43.

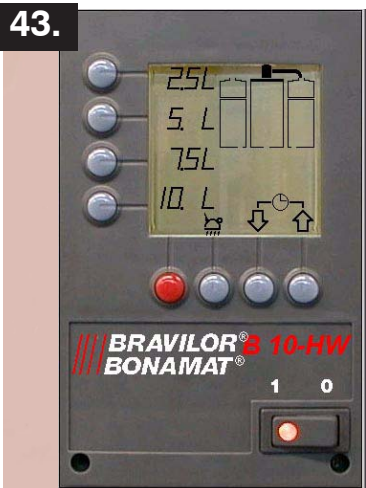

## 4. DESCALING HOT WATER SYSTEM (B HW)

± 30 MIN.

(OPERATOR)

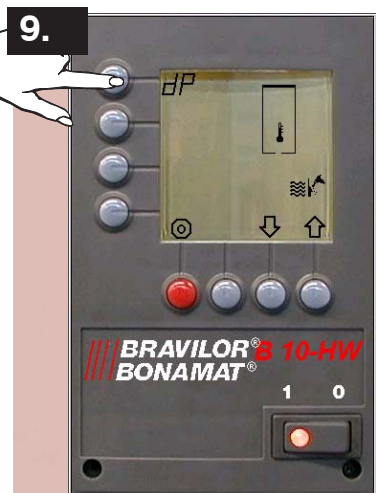
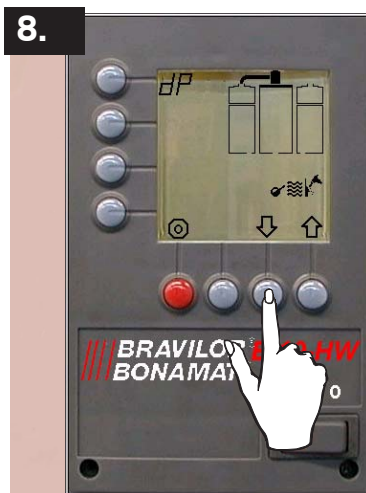
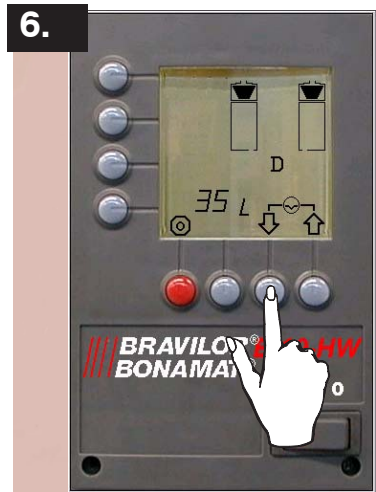
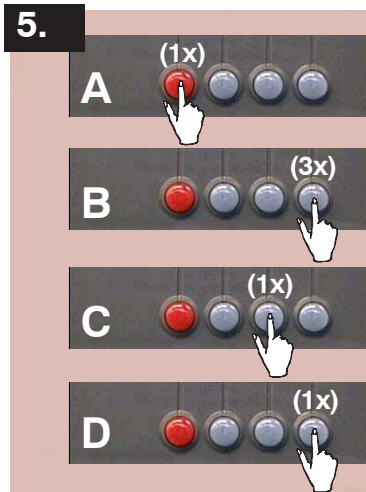

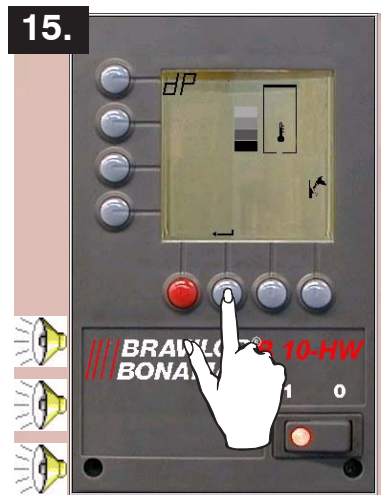
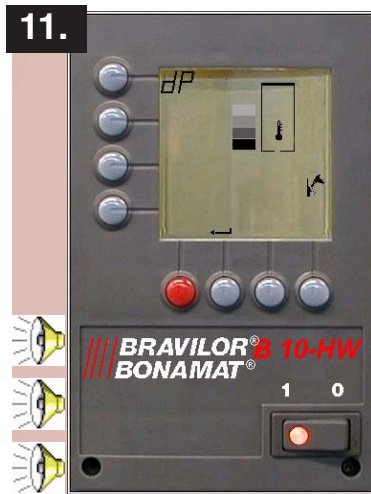
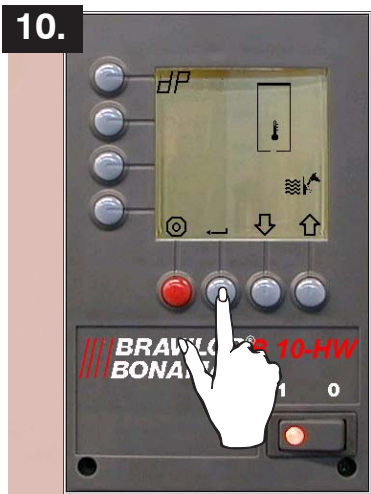

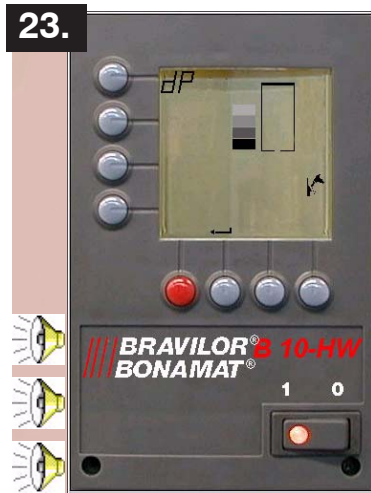
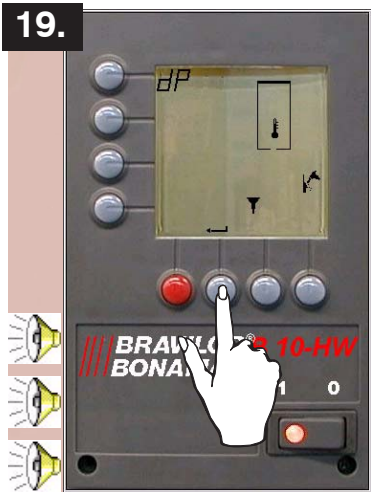



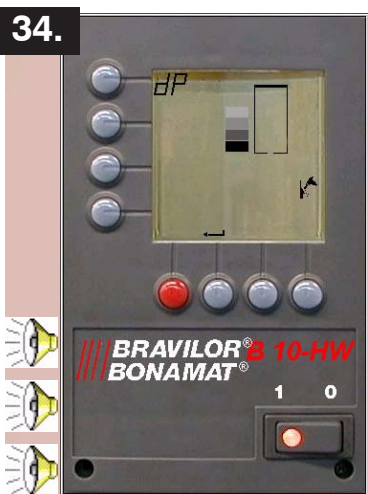
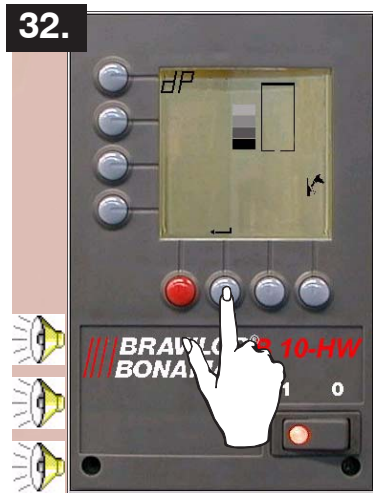

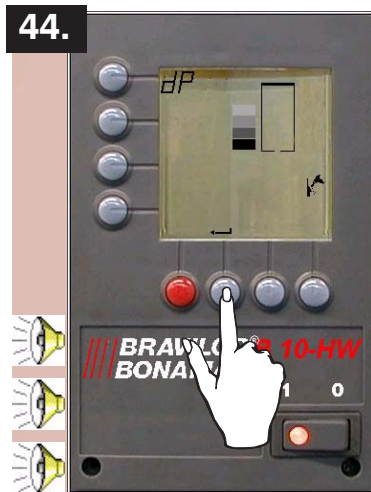
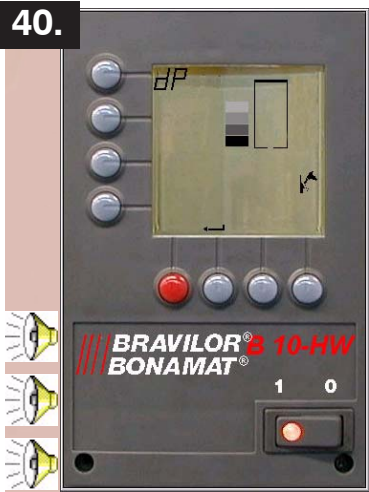
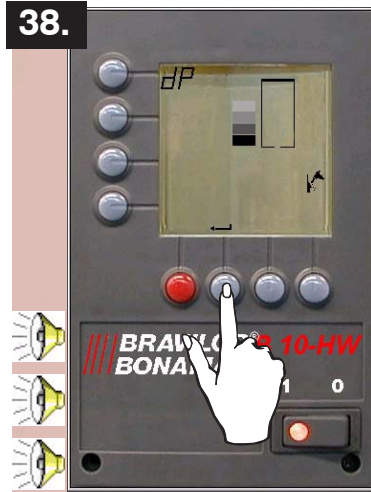

46.



47.





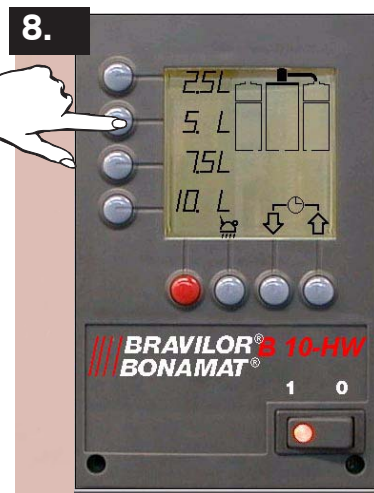
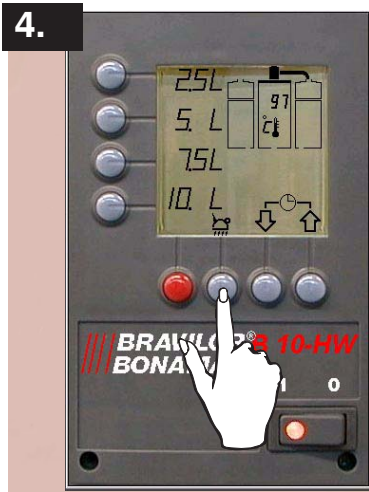
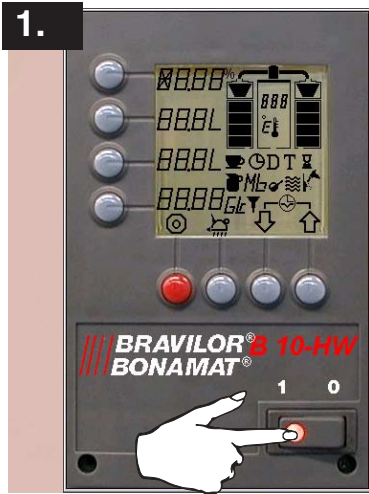

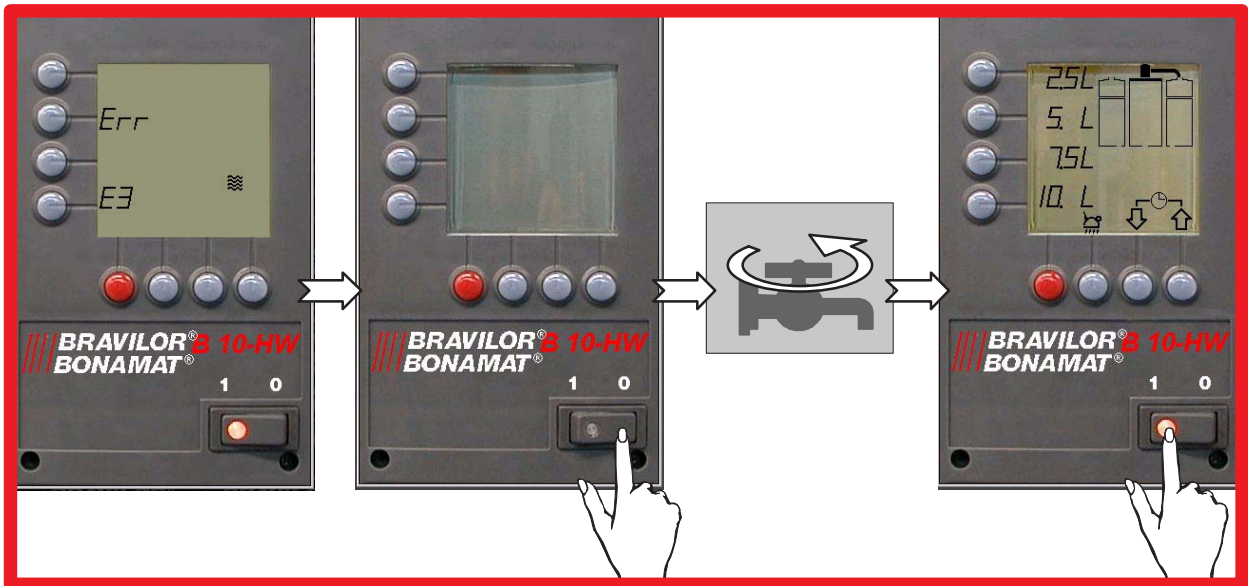



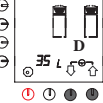

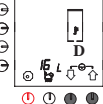

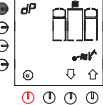

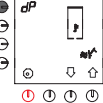

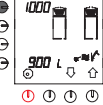

## 5. INITIAL USE (B HW)

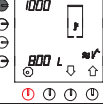

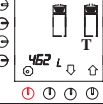

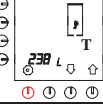





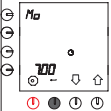
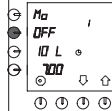
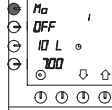
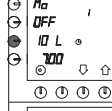
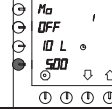

## 6. PROGRAMMING (B HW) (OPERATOR)

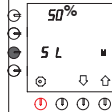
				= 0	
				= 0	
			§ 3.		
			§ 4.		
					
					
					
					
					

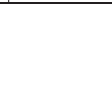
## 7. PROGRAMMING (B HW) (PRINCIPAL USER)

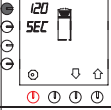
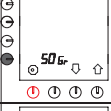
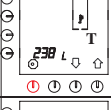
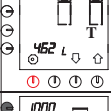
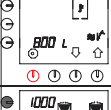
				<table style="width: 100%; border-collapse: collapse;"> <tr> <td style="width: 10%;"></td> <td style="width: 10%; text-align: center;">□</td> <td style="width: 10%;"></td> <td style="width: 10%; text-align: center;">▲</td> <td style="width: 10%;"></td> <td style="width: 10%; text-align: center;">■</td> </tr> <tr> <td>B5 HW</td> <td>4.8</td> <td></td> <td>5.3</td> <td></td> <td>5.8</td> </tr> <tr> <td>B10 HW</td> <td>10.6</td> <td></td> <td>9.6</td> <td></td> <td>11.6</td> </tr> <tr> <td>B20 HW</td> <td>19.2</td> <td></td> <td>21.2</td> <td></td> <td>23.2</td> </tr> </table>		□		▲		■	B5 HW	4.8		5.3		5.8	B10 HW	10.6		9.6		11.6	B20 HW	19.2		21.2		23.2																																																																																				
	□		▲		■																																																																																																											
B5 HW	4.8		5.3		5.8																																																																																																											
B10 HW	10.6		9.6		11.6																																																																																																											
B20 HW	19.2		21.2		23.2																																																																																																											
				<table style="width: 100%; border-collapse: collapse;"> <tr> <td style="width: 10%;"></td> <td style="width: 10%; text-align: center;">□</td> <td style="width: 10%;"></td> <td style="width: 10%; text-align: center;">▲</td> <td style="width: 10%;"></td> <td style="width: 10%; text-align: center;">■</td> </tr> <tr> <td>B5 HW</td> <td>1</td> <td>1</td> <td>3-4</td> <td>5</td> <td>5</td> </tr> <tr> <td>B10 HW</td> <td>2</td> <td>2.5-5</td> <td>7.5-10</td> <td>10</td> <td>10</td> </tr> <tr> <td>B20 HW</td> <td>4</td> <td>5</td> <td>-10-15</td> <td>-20</td> <td>20</td> </tr> </table> <table style="width: 100%; border-collapse: collapse;"> <tr> <td style="width: 10%;"></td> <td style="width: 10%; text-align: center;">□</td> <td style="width: 10%;"></td> <td style="width: 10%; text-align: center;">▲</td> <td style="width: 10%;"></td> <td style="width: 10%; text-align: center;">■</td> </tr> <tr> <td></td> <td>50</td> <td></td> <td>125</td> <td></td> <td>200</td> </tr> </table> <table style="width: 100%; border-collapse: collapse;"> <tr> <td style="width: 10%;"></td> <td style="width: 10%; text-align: center;">□</td> <td style="width: 10%;"></td> <td style="width: 10%; text-align: center;">▲</td> <td style="width: 10%;"></td> <td style="width: 10%; text-align: center;">■</td> </tr> <tr> <td>B5 HW</td> <td>8</td> <td>8-24</td> <td>32-40</td> <td>40</td> <td>40</td> </tr> <tr> <td>B10 HW</td> <td>20</td> <td>20-40</td> <td>60-80</td> <td>80</td> <td>80</td> </tr> <tr> <td>B20 HW</td> <td>40</td> <td>40-80</td> <td>120-160</td> <td>160</td> <td>160</td> </tr> </table> <table style="width: 100%; border-collapse: collapse;"> <tr> <td style="width: 10%;"></td> <td style="width: 10%; text-align: center;">□</td> <td style="width: 10%;"></td> <td style="width: 10%; text-align: center;">▲</td> <td style="width: 10%;"></td> <td style="width: 10%; text-align: center;">■</td> </tr> <tr> <td>B5 HW</td> <td>4</td> <td>4-12</td> <td>16-20</td> <td>20</td> <td>20</td> </tr> <tr> <td>B10 HW</td> <td>10</td> <td>10-20</td> <td>30-40</td> <td>40</td> <td>40</td> </tr> <tr> <td>B20 HW</td> <td>20</td> <td>20-40</td> <td>60-80</td> <td>80</td> <td>80</td> </tr> </table> <table style="width: 100%; border-collapse: collapse;"> <tr> <td style="width: 10%;"></td> <td style="width: 10%; text-align: center;">□</td> <td style="width: 10%;"></td> <td style="width: 10%; text-align: center;">▲</td> <td style="width: 10%;"></td> <td style="width: 10%; text-align: center;">■</td> </tr> <tr> <td>B5 HW</td> <td>0.30</td> <td>0.30-0.65</td> <td>0.95-1.30</td> <td>1.30</td> <td>1.30</td> </tr> <tr> <td>B10 HW</td> <td>0.65</td> <td>0.65-1.30</td> <td>1.95-2.60</td> <td>2.60</td> <td>2.60</td> </tr> <tr> <td>B20 HW</td> <td>1.30</td> <td>1.30-2.60</td> <td>3.95-5.25</td> <td>5.25</td> <td>5.25</td> </tr> </table>		□		▲		■	B5 HW	1	1	3-4	5	5	B10 HW	2	2.5-5	7.5-10	10	10	B20 HW	4	5	-10-15	-20	20		□		▲		■		50		125		200		□		▲		■	B5 HW	8	8-24	32-40	40	40	B10 HW	20	20-40	60-80	80	80	B20 HW	40	40-80	120-160	160	160		□		▲		■	B5 HW	4	4-12	16-20	20	20	B10 HW	10	10-20	30-40	40	40	B20 HW	20	20-40	60-80	80	80		□		▲		■	B5 HW	0.30	0.30-0.65	0.95-1.30	1.30	1.30	B10 HW	0.65	0.65-1.30	1.95-2.60	2.60	2.60	B20 HW	1.30	1.30-2.60	3.95-5.25	5.25	5.25
	□		▲		■																																																																																																											
B5 HW	1	1	3-4	5	5																																																																																																											
B10 HW	2	2.5-5	7.5-10	10	10																																																																																																											
B20 HW	4	5	-10-15	-20	20																																																																																																											
	□		▲		■																																																																																																											
	50		125		200																																																																																																											
	□		▲		■																																																																																																											
B5 HW	8	8-24	32-40	40	40																																																																																																											
B10 HW	20	20-40	60-80	80	80																																																																																																											
B20 HW	40	40-80	120-160	160	160																																																																																																											
	□		▲		■																																																																																																											
B5 HW	4	4-12	16-20	20	20																																																																																																											
B10 HW	10	10-20	30-40	40	40																																																																																																											
B20 HW	20	20-40	60-80	80	80																																																																																																											
	□		▲		■																																																																																																											
B5 HW	0.30	0.30-0.65	0.95-1.30	1.30	1.30																																																																																																											
B10 HW	0.65	0.65-1.30	1.95-2.60	2.60	2.60																																																																																																											
B20 HW	1.30	1.30-2.60	3.95-5.25	5.25	5.25																																																																																																											
				<table style="width: 100%; border-collapse: collapse;"> <tr> <td style="width: 10%;"></td> <td style="width: 10%; text-align: center;">□</td> <td style="width: 10%;"></td> <td style="width: 10%; text-align: center;">▲</td> <td style="width: 10%;"></td> <td style="width: 10%; text-align: center;">■</td> </tr> <tr> <td></td> <td>88</td> <td></td> <td>97</td> <td></td> <td>97</td> </tr> </table> <table style="width: 100%; border-collapse: collapse;"> <tr> <td style="width: 10%;"></td> <td style="width: 10%; text-align: center;">□</td> <td style="width: 10%;"></td> <td style="width: 10%; text-align: center;">▲</td> <td style="width: 10%;"></td> <td style="width: 10%; text-align: center;">■</td> </tr> <tr> <td></td> <td>190</td> <td></td> <td>206</td> <td></td> <td>206</td> </tr> </table>		□		▲		■		88		97		97		□		▲		■		190		206		206																																																																																				
	□		▲		■																																																																																																											
	88		97		97																																																																																																											
	□		▲		■																																																																																																											
	190		206		206																																																																																																											
				<p style="text-align: center;">▲ EnG</p> <p style="text-align: center;">□ ■ dEu, FrA, ESP, nEd</p>   <p style="text-align: center;">▲</p> <p style="text-align: center;">☒ - - - - ■</p> <p style="text-align: center;">off            on</p>																																																																																																												

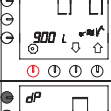
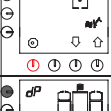
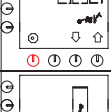
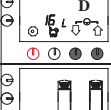
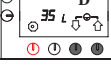
		<p>↓ / ↑</p> <p>Select desired time setting (1-14).</p>		<p>← / ⊙</p>	<p>▲</p> <p>☒ - - - - ■</p> <p>off      on</p>
	<p>↓</p> <p>↑</p>			<p>↓ / ↑</p>	
				<p>← / ⊙</p>	
		<p>↓ / ↑</p>			
	<p>↓</p> <p>↑</p>	<p>↓</p>	<p>←</p>	<p>↓ / ↑</p> <p>← / ⊙</p>	
	<p>↓</p> <p>↑</p>			<p>↓ / ↑</p> <p>← / ⊙</p>	
	<p>↓</p> <p>↑</p>			<p>↓ / ↑</p> <p>← / ⊙</p>	
	<p>↓</p> <p>↑</p>			<p>↓ / ↑</p> <p>← / ⊙</p>	
	<p>↓</p> <p>↑</p>			<p>↓ / ↑</p> <p>← / ⊙</p>	
	<p>↓</p> <p>↑</p>				
	<p>↓</p> <p>↑</p>				
	<p>↓</p> <p>↑</p>			<p>↓ / ↑</p> <p>← / ⊙</p>	
	<p>↓</p> <p>↑</p>			<p>↓ / ↑</p> <p>← / ⊙</p>	
	<p>↓</p> <p>↑</p>				§ 4. (Operator)
	<p>↓</p> <p>↑</p>				§ 3. (Operator)
	<p>↓</p> <p>↑</p>			<p>↓ + ↑</p>	= 0
	<p>↓</p> <p>↑</p>			<p>↓ + ↑</p>	= 0



## 8. ERROR CODES (B HW)

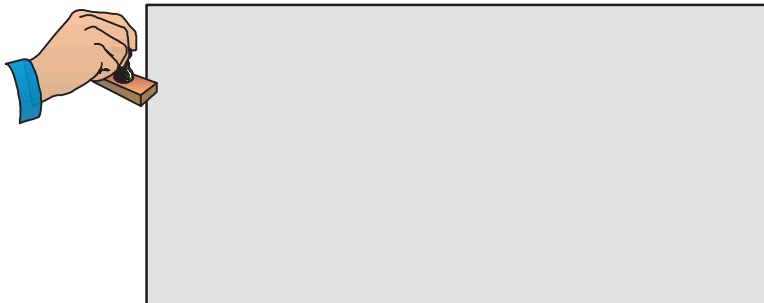
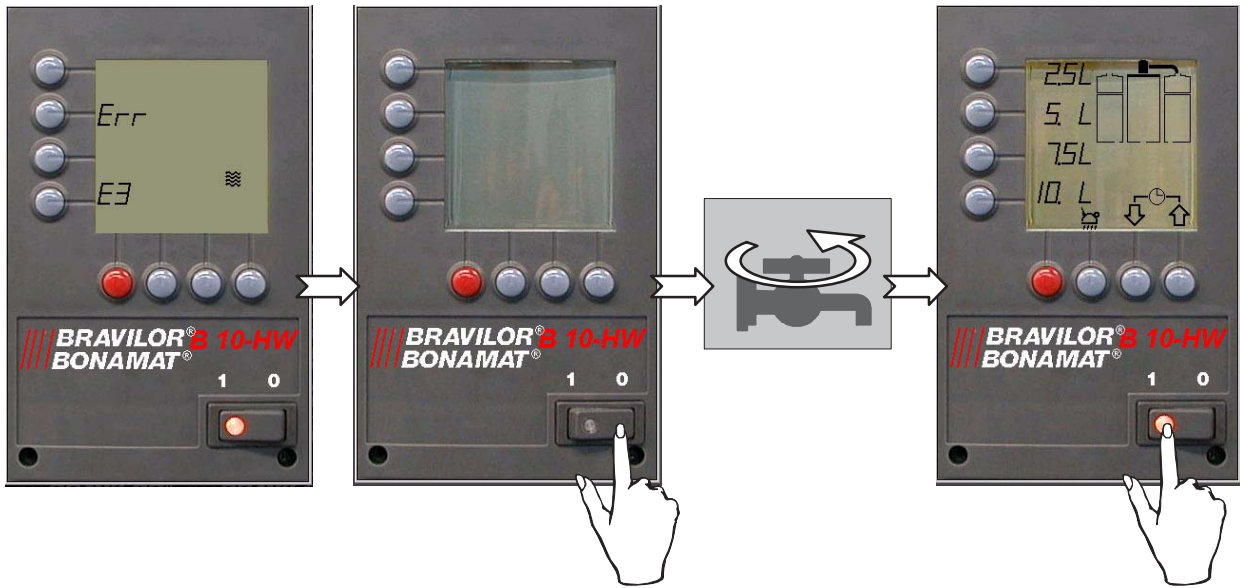



**/// BRAVILOR<sup>®</sup>  
BONAMAT**

COFFEE BREWING MACHINES  
MACHINES A CAFE  
KAFFEEBRUEHMASCHINEN  
KOFFIEZETAPPARATEN

© 11-2001

700.403.801